



Ergonomic Computer and Audio  
Visual Mounting Solutions



**ErgoMounts Limited** as the name suggests specialise in ergonomic mounting solutions for LCD, LED, TFT monitors, plasma TVs, keyboards, CPUs and more recently iPads and tablets.

ErgoMounts provide a range of unique, durable, flexible, client led mounting solutions for office, financial, healthcare and industrial applications.

Our UK based team offers a high quality sales and support service, along with friendly advice and guidance on our full range of solutions.

**ErgoMounts** have a comprehensive database of all leading manufacturers LCD, TFT and LED monitors and can very quickly cross reference our database for compatibility.



| VESA  | LCD size  | LCD Max weight   | Hole positions (mm)                |
|-------|-----------|------------------|------------------------------------|
| MIS-D | 12"-22.9" | 30.8lbs / 14kg   | 75 x 75,<br>100 x 100              |
| MIS-E | 23"-30.9" | 50lbs / 23.7kg   | 200 x 100                          |
| MIS-F | >31"      | 250lbs / 113.6kg | 200 x 200, 400 x 200,<br>600 x 400 |

**Page 5**  
New ParaMotion with finger touch articulation and adjustment.



**Page 6**  
Multiple mount LCD LED monitor stands and supports for office and financial environments.



**Page 10**  
Ergonomic desk mount LCD LED monitor arms front and back office applications.

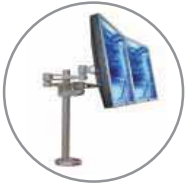

**Page 13**  
Plasma and large format LCD LED (TV) mounts for reception, trading floor and board room use.



**Page 23**  
Ergonomic laptop support arm for office, production and business environments.



**Page 25**  
Projector Mounts.



**Page 26**  
CPU holders. Under desk and wall mount, front and back office use.



**Page 28**  
Components.



An ergonomic working environment has been proven to increase employee productivity and reduce absenteeism. Our range of mounts support the latest generation of LCD, LED TVs and plasmas, ideal for use in the home or office environment. All **ErgoMounts** LCD monitor arms adhere to the VESA interface standards (see chart) and we can even provide bespoke interfaces for non VESA standard screens.

**ErgoMounts** also incorporate a custom/bespoke design service. This service enables us to create a solution to match your exact requirements either from existing components or from scratch. We will work with you to design a brief, prototype and roll-out schedule.

This service has vast experience within the retail, financial, medical and hospitality sectors.

**Suppliers to:**







**ErgoMounts** provide the widest portfolio of specialist solutions aimed at the financial trading market. The modern trading floor is predominantly IT based and restrictions on space are ever present. Our portfolio includes LCD and LED monitor stands capable of supporting up to eight LCD / LED monitors. The VisionPro, UltraView, Trader Stand are used daily by financial professionals throughout the UK and Europe.

Back office ergonomics are also key to a successful and productive workplace. Using an LCD / LED monitor arm not only provides individual users with the ability to adjust their monitor to their correct viewing position but also frees up valuable work space. Combined with an under desk CPU holder, users can reclaim space that would otherwise not be usable.



With over 20 years combined experience of designing, manufacturing and distributing we pride ourselves on our range of space efficient solutions and our product knowledge but above all our customer service. With a database of over 8,500 LCD / LED monitors, TVs and plasmas we can quickly identify compatible solutions. We will go that extra mile to help you in selecting the right solution to meet your needs.

**ErgoMounts** can also provide a complete installation service for both LCD, LED and Plasma based solutions. These include wall and ceiling mounts for LCD, LED and plasma along with multiple LCD / LED monitor stands.

***“At ErgoMounts we will go that extra mile to help you in selecting the right solution to meet your needs.”***





## ParaMotion Series LCD LED Monitor Support Arm



The **EMPMA101S** ParaMotion Series Arm offers finger touch height adjustment and articulation without the need for additional tools.

The ParaMotion has a unique parallel head unit enabling repositioning of the arm whilst maintaining the angle of the LCD / LED monitor. The monitor can move freely from landscape to portrait and tilt +90°/-40° enabling repositioning dependant upon user.

The perfect solution for both home and office applications, helping to reduce eye, neck and back strain. It mounts easily to the desk via either a desk clamp or bolt through desk mount / grommet. The grommet fits neatly through the cable management hole reducing the need for additional drilling.

The ParaMotion offers up to 525mm of height adjustment and up to 500mm of reach, perfect for meeting the ergonomic needs of 95% of adults.

Available in a silver finish.

ParaMotion LCD Support Arm, extended, desk clamp and bolt through fitting. **EMPMA101S**  
Silver finish.

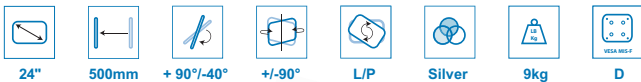

## ParaMotion Series Dual Horizontal LCD LED Monitor Support Arm



The **EMPMA212S** ParaMotion Dual Series Arm offers finger touch height adjustment and articulation without the need for additional tools.

The ParaMotion has a unique parallel head unit enabling repositioning of the arm whilst maintaining the angle of the LCD / LED monitor. The monitor can move freely from landscape to portrait and tilt +90°/-40° enabling repositioning dependant upon user.

The ParaMotion is the perfect solution for both home and office applications. As well as improving productivity it also helps to reduce eye, neck and back strain. Offering up to 525mm of height adjustment and up to 500mm of reach the mount perfectly meets the ergonomic criteria of 95% of adults.

The mount can support up to 18kg on a single 35mm pole in a horizontal mounting configuration. The monitors can be moved from landscape to portrait and tilt +90°/-40° enabling repositioning dependant upon user.

Available in a silver finish.

ParaMotion LCD Support Arm, supporting two LCD monitors, extended, desk clamp and bolt through fitting. Maximum mount capacity 18kg. Silver finish. **EMPMA212S**



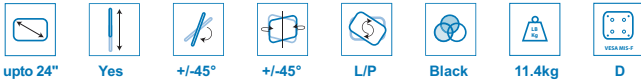

## VisionPro 300 Series

The **ErgoMounts VisionPro 300 Series** is the ultimate future proof range of multiple LCD / LED mounting solutions. Solid ergonomic design combined with flexible configuration supports ever changing needs. Supporting between one and eight LCD / LED monitors and available with free standing, desk clamp or bolt through desk fittings. All configurations are cable managed across the horizontal cross bars. Monitors can tilt, angle left to right and move through portrait to landscape.



- 1 Dual Horizontal Mount Desk Clamp **EMVP312DC**
- Dual Horizontal Mount Bolt Through **EMVP312TD**
- Dual Horizontal Mount Free Standing **EMVP312FS**

Monitors Supported 2  
Max Monitor Width 540mm

- 2 Dual Vertical Mount Desk Clamp **EMVP321DC**
- Dual Vertical Mount Bolt Through **EMVP321TD**
- Dual Vertical Mount Free Standing **EMVP321FS**

Monitors Supported 2  
Max Monitor Width 570mm

- 3 Triple Horizontal Mount Desk Clamp **EMVP313DC**
- Triple Horizontal Mount Bolt Through **EMVP313TD**
- Triple Horizontal Mount Free Standing **EMVP313FS**

Monitors Supported 3  
Max Monitor Width 435mm

- 4 Triple Vertical Mount Desk Clamp **EMVP333DC**
- Triple Vertical Mount Bolt Through **EMVP333TD**
- Triple Vertical Mount Free Standing **EMVP333FS**

Monitors Supported 3  
Max Monitor Width 570mm

- 5 Quad (2x2) Mount Desk Clamp **EMVP322DC**
- Quad (2x2) Mount Bolt Through **EMVP322TD**
- Quad (2x2) Mount Free Standing **EMVP322FS**

Monitors Supported 4  
Max Monitor Width 540mm

- 6 6 Way (3x2) Mount Desk Clamp **EMVP323DC**
- 6 Way (3x2) Mount Bolt Through **EMVP323TD**
- 6 Way (3x2) Mount Free Standing **EMVP323FS**

Monitors Supported 6  
Max Monitor Width 435mm

- 7 8 Way (4x2) Mount Desk Clamp **EMVP324DC**
- 8 Way (4x2) Mount Bolt Through **EMVP324TD**
- 8 Way (4x2) Mount Free Standing **EMVP324FS**

Monitors Supported 8  
Max Monitor Width 485mm

\* Optional EMVP3-VESAEXT extension plates for triple horizontal configurations - extends max monitor width to 515mm per monitor.

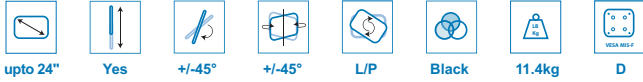

## VisionPro 300 EXT Series

The **ErgoMounts** VisionPro 300 EXT Series builds on the successful VisionPro 300 series and is enhanced to support today's wider LCD and LED monitors.

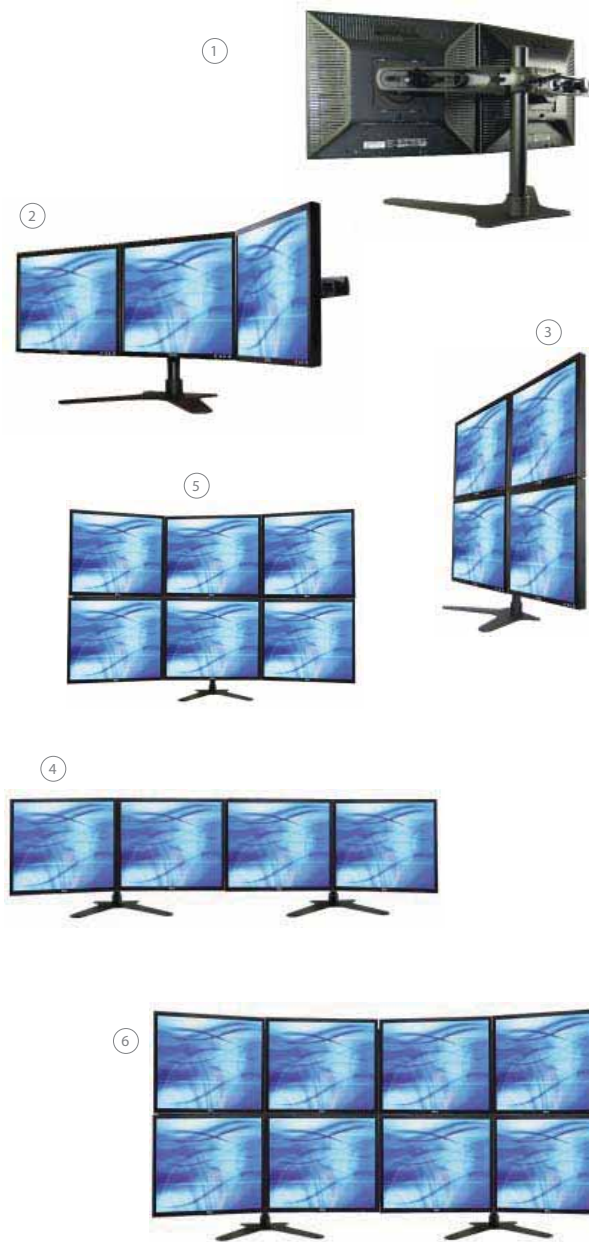

- 1 Dual Horizontal Mount Desk Clamp  
Dual Horizontal Mount Bolt Through  
Dual Horizontal Mount Free Standing

Monitors Supported: 2  
Max Monitor Width: 620mm

- 2 Triple Horizontal Mount Desk Clamp  
Triple Horizontal Mount Bolt Through  
Triple Horizontal Mount Free Standing

Monitors Supported: 3  
Max Monitor Width: 515mm

- 3 Quad Mount 2x2 Desk Clamp  
Quad Mount 2x2 Bolt Through  
Quad Mount 2x2 Free Standing

Monitors Supported: 4  
Max Monitor Width: 620mm

- 4 Quad Mount Horizontal Desk Clamp  
Quad Mount Horizontal Bolt Through  
Quad Mount Horizontal Free Standing

Monitors Supported: 4  
Max Monitor Width: 515mm

- 5 6-Way Mount Desk Clamp  
6-Way Mount Bolt Through  
Quad Mount Free Standing

Monitors Supported: 6  
Max Monitor Width: 515mm

- 6 8-Way Mount Desk Clamp  
8-Way Mount Bolt Through  
8-Way Mount Free Standing

Monitors Supported: 8  
Max Monitor Width: 515mm

- 7 Quad Mount Desk Clamp  
Quad Mount Bolt Through  
Quad Mount Free Standing

Monitors Supported: 4  
Max Monitor Width: 575mm

- 8 8-Way Mount Desk Clamp  
8-Way Mount Bolt Through  
8-Way Mount Free Standing

Monitors Supported: 8  
Max Monitor Width: 575mm

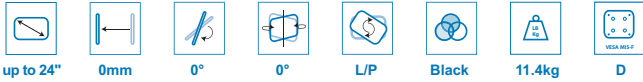

## VisionPro 3500 Series



The **ErgoMounts VisionPro 3500 Series Triple Horizontal 24" LCD Monitor Support** allows the arrangement of three LCD monitors in a parabolic placement for simultaneous viewing. ErgoMounts responded to demand for a triple mount capable of supporting larger screens. ErgoMounts designed, developed and manufactured the VisionPro 3500 Series, capable of holding three 24" monitors (each up to a maximum of 600mm wide).

The angle adjustable horizontal crosswings and adjustable pivot mounts allow monitor bezels to be positioned together and without gaps.







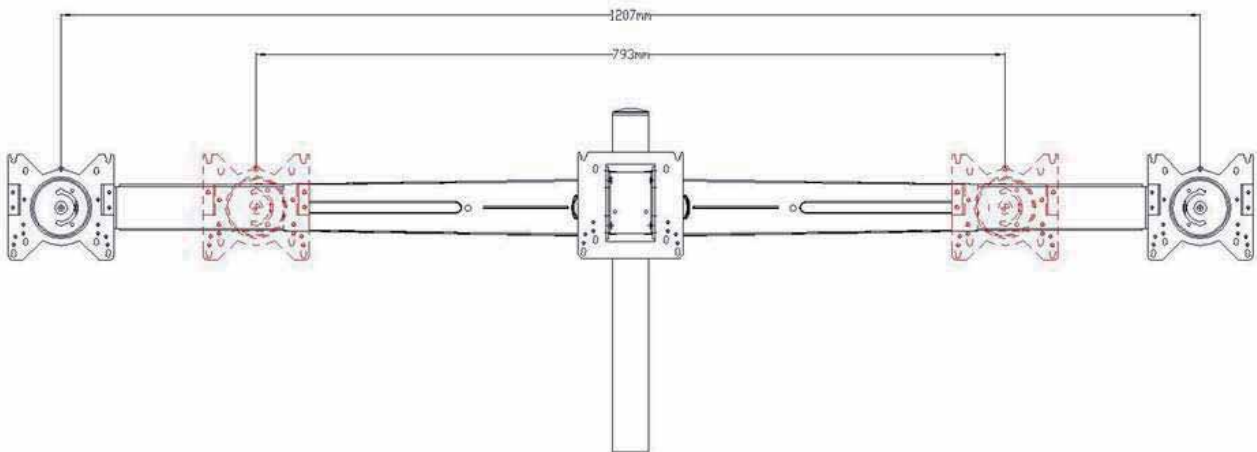

Available as either a desk clamp, bolt through or free standing mount this solution frees up valuable desk space whilst enabling multiple application use.

- 1 VisionPro 3513. Triple horizontal 24" LCD monitor support, 355mm (14") pole, free standing base. Black finish. **EMVP3513 FS**
- 2 VisionPro 3513. Triple horizontal 24" LCD monitor support, 355mm (14") pole, desk clamp fitting. Black finish. **EMVP3513 DC**
- 3 VisionPro 3513. Triple horizontal 24" LCD monitor support, 355mm (14") pole, bolt through desk fitting. Black finish. **EMVP3513 TD**

Monitors Supported **3**  
 Max Monitor Width **390mm - 600mm**





-   
upto 24"
-   
Yes
-   
+/-37.5°
-   
+/-37.5°
-   
L/P
-   
Silver/black
-   
8/15kg
-   
D

## Trader Stand Series



①

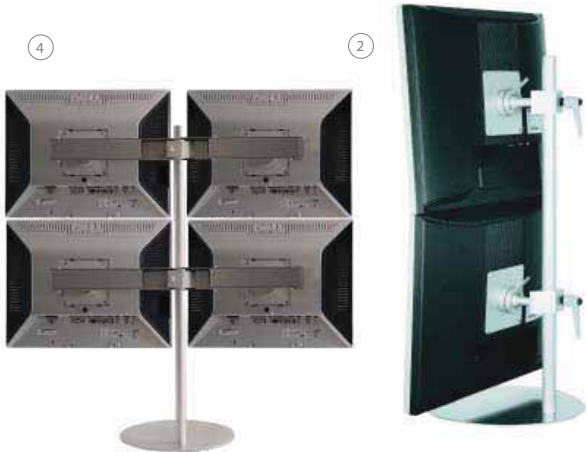

④

②



③\*



⑤\*

The **ErgoMounts** Trader Stand Series is manufactured in the UK to exacting standards. Supporting between one and six LCD / LED monitors on a single pole the Trader Stand Series is available with a free standing, desk clamp or bolt through desk fitting. Supports allow each monitor to slide across the horizontal cross bars enabling bezels to be positioned in the perfect viewing position. Each monitor is attached via a Teflon coated ball joint that allows tilt, angle left to right and portrait to landscape movement. Silver or black finish.

- |   |   |
|---|---|
| <ul style="list-style-type: none"> <li>1 Dual Horizontal Mount Desk Clamp, Silver</li> <li>Dual Horizontal Mount Bolt Through, Silver</li> <li>Dual Horizontal Mount Free Standing, Silver</li> </ul>       | <ul style="list-style-type: none"> <li><b>EM502DC</b></li> <li><b>EM502TD</b></li> <li><b>EM502FS</b></li> </ul>    |
| <ul style="list-style-type: none"> <li>Dual Horizontal Mount Desk Clamp, Black</li> <li>Dual Horizontal Mount Bolt Through, Black</li> <li>Dual Horizontal Mount Free Standing, Black</li> </ul>            | <ul style="list-style-type: none"> <li><b>EM502BDC</b></li> <li><b>EM502BTD</b></li> <li><b>EM502BFS</b></li> </ul> |
| <p>Max Monitor Width</p>  | <p>575mm</p>  |
| <ul style="list-style-type: none"> <li>2 Dual Vertical Mount Desk Clamp, Silver</li> <li>Dual Vertical Mount Bolt Through, Silver</li> <li>Dual Vertical Mount Free Standing, Silver</li> </ul>             | <ul style="list-style-type: none"> <li><b>EM503DC</b></li> <li><b>EM503TD</b></li> <li><b>EM503FS</b></li> </ul>    |
| <ul style="list-style-type: none"> <li>Dual Vertical Mount Desk Clamp, Black</li> <li>Dual Vertical Mount Bolt Through, Black</li> <li>Dual Vertical Mount Free Standing, Black</li> </ul>                  | <ul style="list-style-type: none"> <li><b>EM503BDC</b></li> <li><b>EM503BTD</b></li> <li><b>EM503BFS</b></li> </ul> |
| <p>Max Monitor Width</p>  | <p>570mm</p>  |
| <ul style="list-style-type: none"> <li>3 Triple Horizontal Mount Desk Clamp, Silver</li> <li>Triple Horizontal Mount Bolt Through, Silver</li> <li>Triple Horizontal Mount Free Standing, Silver</li> </ul> | <ul style="list-style-type: none"> <li><b>EM507DC</b></li> <li><b>EM507TD</b></li> <li><b>EM507FS</b></li> </ul>    |
| <ul style="list-style-type: none"> <li>Triple Horizontal Mount Desk Clamp, Black</li> <li>Triple Horizontal Mount Bolt Through, Black</li> <li>Triple Horizontal Mount Free Standing, Black</li> </ul>      | <ul style="list-style-type: none"> <li><b>EM507BDC</b></li> <li><b>EM507BTD</b></li> <li><b>EM507BFS</b></li> </ul> |
| <p>Max Monitor Width</p>  | <p>485mm</p>  |
| <ul style="list-style-type: none"> <li>4 Quad (2x2) Mount Desk Clamp, Silver</li> <li>Quad (2x2) Mount Bolt Through, Silver</li> <li>Quad (2x2) Mount Free Standing, Silver</li> </ul>                      | <ul style="list-style-type: none"> <li><b>EM504DC</b></li> <li><b>EM504TD</b></li> <li><b>EM504FS</b></li> </ul>    |
| <ul style="list-style-type: none"> <li>Quad (2x2) Mount Desk Clamp, Black</li> <li>Quad (2x2) Mount Bolt Through, Black</li> <li>Quad (2x2) Mount Free Standing, Black</li> </ul>                           | <ul style="list-style-type: none"> <li><b>EM504BDC</b></li> <li><b>EM504BTD</b></li> <li><b>EM504BFS</b></li> </ul> |
| <p>Max Monitor Width</p>  | <p>575mm</p>  |
| <ul style="list-style-type: none"> <li>5 Six Way (3x2) Mount Desk Clamp, Silver</li> <li>Six Way (3x2) Mount Bolt Through, Silver</li> <li>Six Way (3x2) Mount Free Standing, Silver</li> </ul>             | <ul style="list-style-type: none"> <li><b>EM508DC</b></li> <li><b>EM508TD</b></li> <li><b>EM508FS</b></li> </ul>    |
| <ul style="list-style-type: none"> <li>Six Way (3x2) Mount Desk Clamp, Black</li> <li>Six Way (3x2) Mount Bolt Through, Black</li> <li>Six Way (3x2) Mount Free Standing, Black</li> </ul>                  | <ul style="list-style-type: none"> <li><b>EM508BDC</b></li> <li><b>EM508BTD</b></li> <li><b>EM508BFS</b></li> </ul> |
| <p>Max Monitor Width</p>  | <p>485mm</p>  |

\* Optional EMVP3-VESAEXT extension plates for triple horizontal configurations - extends max monitor width to 565mm per monitor.

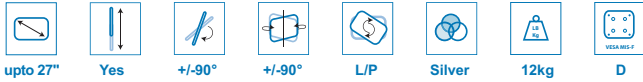

## UltraView 400 Series

The **ErgoMounts** UltraView 400 Series is the all new, multi-adjustable series of multiple mount solutions for LCD / LED monitors. Supporting LCD monitors up to 24" or LED monitors up to 27" in size this series provides a strong, durable range of mounting options from 1 - 4 LCD monitors on a single pole. The dual and quad mount versions allow each monitor to be pulled towards the user to create a more comfortable viewing position. All finished in a hard wearing silver powder coating. Alternative configurations are available on request.



|   |  |                                      |
|---|--|--------------------------------------|
| 1 | Single Mount Desk Clamp<br>Single Mount Bolt through                   | <b>EMUV400DC</b><br><b>EMUV400TD</b> |
|   | Monitors Supported   | 1                                    |
|   | Max Monitor Width  | 680mm                                |
| 2 | Dual Horizontal Mount Desk Clamp<br>Dual Horizontal Mount Bolt Through | <b>EMUV420DC</b><br><b>EMUV420TD</b> |
|   | Monitors Supported   | 2                                    |
|   | Max Monitor Width  | 680mm                                |
| 3 | Dual Vertical Mount Desk Clamp<br>Dual Vertical Mount Bolt Through     | <b>EMUV425DC</b><br><b>EMUV425TD</b> |
|   | Monitors Supported   | 2                                    |
|   | Max Monitor Width  | 680mm                                |
| 4 | Dual Vertical Mount Free Standing                                      | <b>EMUV430FS</b>                     |
|   | Monitors Supported   | 2                                    |
|   | Max Monitor Width  | 680mm                                |
| 5 | Quad Mount Desk Clamp<br>Quad Mount Bolt Through                       | <b>EMUV440DC</b><br><b>EMUV440TD</b> |
|   | Monitors Supported   | 4                                    |
|   | Max Monitor Width  | 680mm                                |
| 6 | Bolt through /grommet mount fitting.<br>Max desk thickness 60mm.       | <b>EMUVXXXTD</b>                     |
| 7 | Desk clamp. Max desk thickness 95mm.                                   | <b>EMUVXXXDC</b>                     |
| 8 | Free Standing Base   | <b>EMUVXXXFS</b>                     |





## VisionPro 6900 Series



The **ErgoMounts** VisionPro 6900 Series is capable of supporting monitors from 9kg upto 20kg in weight. With +/-90° rotation, +/-90° tilt and +/-90° swivel the arm provides the widest range of viewing positions of any monitor arm of its type. The parallel head unit enables finger touch repositioning of the arm whilst maintaining the angle of the monitor. Available in desk clamp, bolt through desk or wall mount fitting, compact (380mm max reach) and extended (560mm max reach). Available in a silver finish.

- 1 VisionPro 6900 Series compact gas assisted LCD arm, desk clamp and bolt through desk fitting. Silver finish. **EMVP6900S**
- 2 VisionPro 6900 Series extended gas assisted LCD arm, desk clamp and bolt through desk fitting. Silver finish. **EMVP6901S**
- 3 VisionPro 6900 Series compact gas assisted LCD arm, wall mount fitting. Silver finish. **EMVP6900SWM**
- 4 VisionPro 6900 Series extended gas assisted LCD arm, wall mount fitting. Silver finish. **EMVP6901SWM**

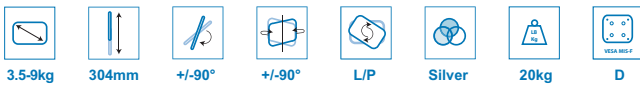

## VisionPro 6900 Series Dual

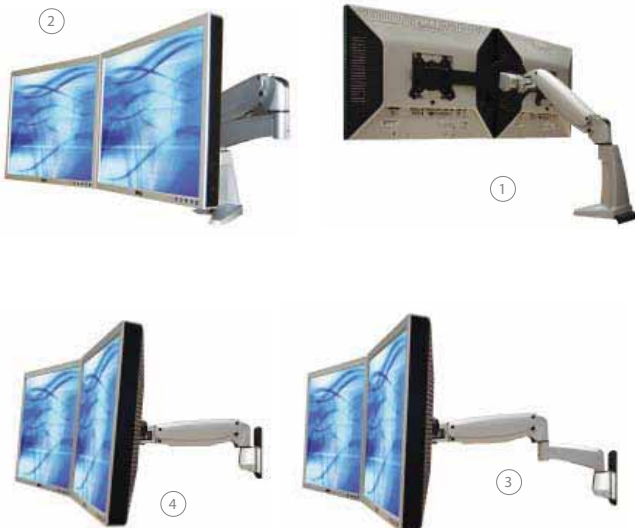

The **ErgoMounts** VisionPro 6900 Series Dual LCD support arm is capable of supporting two monitors 445mm - 600mm and each weighing between 3.5kg - 9kg in a dual horizontal or dual vertical configuration. With +/-90° rotation, +/-90° tilt and +/-90° swivel the arm provides the widest range of viewing positions of any monitor arm of its type. The parallel head unit enables finger touch repositioning of the arm whilst maintaining the angle of the monitor. Available in desk clamp, bolt through desk or wall mount fitting, compact (380mm max reach) and extended (560mm max reach). Available in a silver finish.

- 1 VisionPro 6900 Series compact gas assisted Dual Mount LCD arm, desk clamp and bolt through desk fitting. Silver finish. **EMVP6900S-DM**
- 2 VisionPro 6900 Series extended gas assisted Dual LCD arm, desk clamp and bolt through desk fitting. Silver finish. **EMVP6901S-DM**
- 3 VisionPro 6900 Series compact gas assisted Dual LCD arm, wall mount fitting. Silver finish. **EMVP6900SWM-DM**
- 4 VisionPro 6900 Series extended gas assisted Dual LCD arm, wall mount fitting. Silver finish. **EMVP6901SWM-DM**



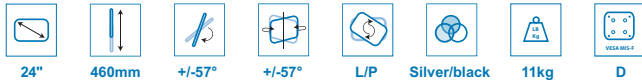

## VisionPro 500 Series

The **ErgoMounts** VisionPro 500 Series provides the widest range of viewing positions and angles of any monitor arm of its type. Designed to suit any application within offices, production or medical environments. The VisionPro 500 can be adjusted in height, extension, tilt and swivel and portrait to landscape to meet all modern ergonomic criteria. Precision manufactured in die-cast aluminium, the VisionPro 500 series provides up to 460mm of height adjustment and 720mm of reach. Supplied with desk clamp mount, bolt through or wall mount fittings.

Silver or black finish.



- |   |  |
|---|--|
| 1 VisionPro 500 Series Compact Gas Assisted LCD arm Clamp and Bolt Through Desk Fitting. Black or Silver finish.    | <b>EMVP500B</b><br><b>EMVP500S</b>     |
| Reach Extension   | 360mm                                  |
| Height Adjustment   | 460mm                                  |
| 2 VisionPro 500 Series Extended Gas Assisted LCD arm Clamp and Bolt Through Desk Fitting. Black or Silver finish.   | <b>EMVP501B</b><br><b>EMVP501S</b>     |
| Reach Extension   | 540mm                                  |
| Height Adjustment   | 460mm                                  |
| 3 VisionPro 500 Series Long Reach Gas Assisted LCD arm Clamp and Bolt Through Desk Fitting. Black or Silver finish. | <b>EMVP502B</b><br><b>EMVP502S</b>     |
| Reach Extension   | 720mm                                  |
| Height Adjustment   | 460mm                                  |
| 4 VisionPro 500 Series Gas Assisted LCD Arm, Wall Mount Fitting. Black or Silver finish.                            | <b>EMVP500BWM</b><br><b>EMVP500SWM</b> |
| Reach Extension   | 360mm                                  |
| Height Adjustment   | 460mm                                  |
| 5 VisionPro 500 Series Extended Gas Assisted LCD Arm, Wall Mount Fitting. Black or Silver finish.                   | <b>EMVP501BWM</b><br><b>EMVP501SWM</b> |
| Reach Extension   | 540mm                                  |
| Height Adjustment   | 460mm                                  |
| 6 VisionPro 500 Series Long Reach Gas Assisted LCD Arm. Wall Mount Fitting. Black or Silver finish.                 | <b>EMVP502BWM</b><br><b>EMVP502SWM</b> |
| Reach Extension   | 720mm                                  |
| Height Adjustment   | 460mm                                  |



## VisionPro F1500 LCD Floor Stand



The **ErgoMounts** EMVPF1500 LCD Floor Stand is sleek in design and suitable for VESA compliant large LCD/Plasma screens up to 32". The heavy weight, free standing base can be bolted to the floor for extra stability. Standard pole heights are 1000mm and 1500mm. Screen centre is pole height plus 250mm. Optional multimedia shelf available. Black base.

LCD size: 32"  
 Movement: +/-15° tilt, +/-180° swivel.  
 VESA: 75mm x 75mm, 100mm x 100mm, 200mm x 100mm (200mm x 200mm optional)  
 Max weight capacity: 24kg  
 Finish colour: Black base, chrome pole  
 Optional extras: Glass multimedia shelf. 200mm x 200mm VESA interface.



## VisionPro F1600 LCD Floor Stand



The **ErgoMounts** EMVPF1600 LCD Floor Stand is sleek in design and suitable for VESA compliant large LCD/Plasma screens up to 55". The Ultra low profile base is fully cable managed as cables can be routed neatly through the chrome pole. Standard pole heights are 1740mm and 1430mm. Optional multimedia shelf available. Black base.

LCD size: 37" - 55"  
 Movement: Adjustable height  
 VESA: 200mm x 100mm, 200mm x 200mm, 400mm x 200mm, 600mm x 400mm and 800mm x 400mm  
 Max weight capacity: 60kg  
 Finish colour: Black base, chrome poles  
 Optional extras: Multi-media shelf.

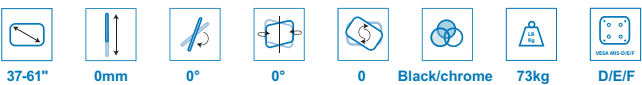

## Trident Universal Plasma Stand



Standing 1820mm (72") tall, the **ErgoMounts** EMPROTD-FM72 is an ideal solution for digital signage and presentation environments. Low profile metal base and optional 84" tall poles, multimedia shelves and cable management covers provide a striking stand.

LCD size: 37" - 61"  
 Movement: Adjustable height  
 VESA: 200mm x 100mm, 200mm x 200mm, 600mm x 400mm and 800mm x 400mm  
 Adjustable mounting: 200mm - 800mm (w), 410mm (h)  
 Max weight capacity: 73kg  
 Finish colour: Black base, chrome poles.  
 Optional extras: Multi-media shelf, 84" poles.

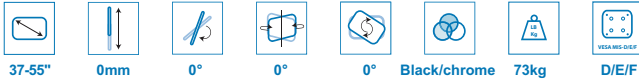

## Phoenix Universal Plasma Trolley



The **ErgoMounts** EMPROPX-FM60 Universal Plasma /LCD Trolley is a durable plasma display / large format LCD screen stand capable of supporting TVs up to 73kg in weight and 37" - 55" in size. Unique base design allows trolleys to be parked together to reduce storage space. Supplied with lockable castors. Optional multimedia shelf.

|                      |   |
|----------------------|---|
| LCD size:            | 37" - 55"   |
| Movement:            | Adjustable height   |
| VESA:                | 200mm x 100mm, 200mm x 200mm, 600mm x 400mm and 800mm x 400mm |
| Max weight capacity: | 73kg  |
| Finish colour:       | Black base, chrome poles.                                     |
| Optional extras:     | Multi-media shelf   |

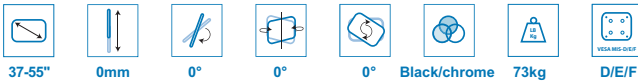

## ProView Series Plasma Trolley



The **ErgoMounts** EMPRO72-FM72 Series comprises a state of the art, sweeping design with capacity for plasma / large LCD screen between 37" and 55" in size and up to 73kg weight. With 1800mm dual support poles and universal interface, the FM72 will accommodate a vast range of screens and comes with levelling feet as standard.

|                      |   |
|----------------------|---|
| LCD size:            | 37" - 55"   |
| Movement:            | 0°  |
| VESA:                | 200mm x 100mm, 200mm x 200mm, 400mm x 200mm, 600mm x 400mm, and 800mm x 400mm |
| Max weight capacity: | 73kg  |
| Finish colour:       | Black base, chrome poles.   |
| Optional extras:     | Multi-media shelf, lockable castors.  |

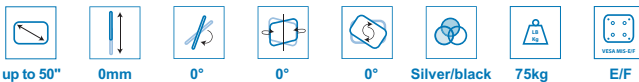

## Delta Series Plasma Trolley



The **ErgoMounts** EM804850B is a high capacity mobile trolley for Plasma and LCD TVs supporting screens up to 50". Ideal for exhibitions and office use with lockable castors and optional multimedia shelf. Adjustable mounting supports VESA 600mm x 400mm standard (optional 200mm x 200mm and 800mm x 400mm interface plates available). Silver or black base.

|                      |   |
|----------------------|---|
| LCD size:            | up to 50"   |
| Movement:            | None  |
| VESA:                | 200mm x 100mm, 200mm x 200mm, 400mm x 200mm and 600mm x 400mm |
| Max weight capacity: | 75kg  |
| Finish colour:       | Silver or black base, chrome poles.                           |
| Optional extras:     | Multi-media shelf   |



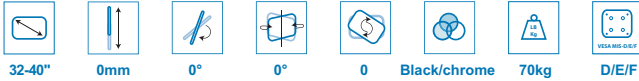

### Trident Dual Horizontal Plasma Stand



The **ErgoMounts** EMPROTD-FM84-2XH is an ideal solution for video conferencing and presentation environments. Low profile metal base and optional 1.8m (72") tall poles, multimedia shelves and cable management covers provide a striking LCD / Plasma stand.

LCD size: 32" - 40"  
 Movement: Adjustable height  
 VESA: 100mm x 100mm, 200mm x 100mm and 200mm x 200mm  
 Max weight capacity: 35kg per monitor  
 Finish colour: Black base, chrome poles.  
 Optional extras: Multi-media shelf, 84" poles, video conferencing, camera shelf.

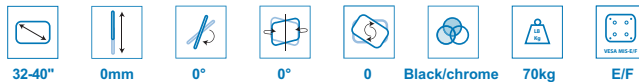

### VisionPro Dual Horizontal Plasma Stand



The **ErgoMounts** VisionPro F1420-X2H Dual Horizontal Plasma/LCD Stand is a durable, large format LCD screen capable of supporting displays/TVs up to 35kg each in weight and 40" in size. Its weighted base can also be bolted to the floor for extra stability. Supplied with 2.0m chrome poles as standard.

LCD size: 32" - 40"  
 Movement: None  
 VESA: 200mm x 100mm, 200mm x 200mm,  
 Max weight capacity: 35kg per monitor  
 Finish colour: Black base, chrome poles.  
 Optional extras: Multi-media shelf

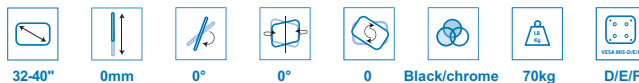

### ProView Dual Horizontal Plasma trolley



The **ErgoMounts** EMPRO72-FM72-X2H is a high quality mobile trolley for plasma/LCD TVs supporting two screens up to 40". Ideal for exhibitions, board rooms and video conferencing. Cables are managed internally through vertical poles. Optional lockable castors, cable management and multimedia shelf. Black base.

LCD size: 32" - 40"  
 Movement: None  
 VESA: 200mm x 100mm, 200mm x 200mm  
 Max weight capacity: 35kg per monitor  
 Finish colour: Black base, chrome poles.  
 Optional extras: Multi-media shelf, lockable castors.

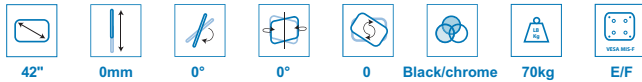

## Trident Dual Vertical Plasma Stand



The **ErgoMounts** EMPROTD-FM84-X2V Dual Vertical Plasma/LCD Stand is a durable, large format LCD stand capable of supporting displays/TVs up to 35kg each in weight (42" in size). Its weighted base can also be bolted to the floor for extra stability.

LCD size: up to 42"  
 Movement: None  
 VESA: 200mm x 100mm and 200mm x 200mm, 400mm x 200mm, 600mm x 400mm and 800mm x 400mm  
 Max weight capacity: 35kg per monitor  
 Finish colour: Black base, chrome poles.  
 Optional extras: Glass or metal multimedia shelf.

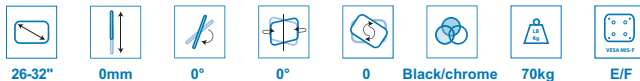

## Delta Quad MMS LCD/Plasma Stand



The **ErgoMounts** EM804-2x2-2B is a high capacity mobile trolley designed to support four 32" LCD screens. Ideal for exhibitions and office use where a free standing multiple monitor solution is required. Supplied with lockable castors and optional multimedia shelf. Supports VESA 100mm x 100mm, 200mm x 100mm and 200mm x 200mm. Black base.

LCD size: 26-32"  
 Movement: None  
 VESA: 100mm x 100mm, 200mm x 100mm and 200mm x 200mm  
 Max weight capacity: 17.5kg per monitor  
 Finish colour: Black base, chrome poles.  
 Optional extras: Multi-media shelf

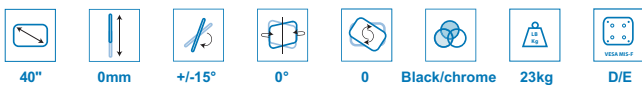

## VisionPro F1200 Plasma Floor Mount



The **ErgoMounts** EMVPF1200 is an ideal digital signage floor mount for screens up to 40"/23kg in weight. Its 290mm x 235mm floor plate securely fixes the system to the floor. Screens are able to tilt +/-10°. Cables run through the centre of the pole. Supports VESA 75mm x 75mm, 100mm x 100mm and 200mm x 100mm.

LCD size: 40"  
 Movement: Tilt +/-10°  
 VESA: 75mm x 75mm, 100mm x 100mm and 200mm x 100mm  
 Max weight capacity: 23kg  
 Finish colour: Black base, chrome pole.  
 Optional extras: Glass shelf and collar 350mm (w) x 300mm (d)

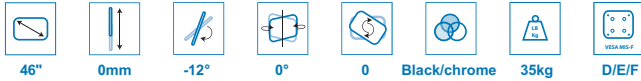

### VisionPro F1250M Plasma Floor Mount



The **ErgoMounts** EMVPF1250M is an ideal digital signage floor mount for larger and non VESA screens up to 46" /40kg in weight. Its 290mm x 235mm floor plate securely fixes the system to the floor. Screens are able to tilt and rotate. Cables run through the centre of the pole. Two interface sizes available.

LCD size: (37" - 46" on M2) and (24" - 36" on M1)  
 Movement: Tilt and rotate  
 VESA: All VESA standards up to 600mm x 400mm  
 Adjustable mounting: 75mm - 780mm (w), 410mm (h)  
 Max weight capacity: 35kg  
 Finish colour: Black base, chrome pole.  
 Optional extras: Multi-media shelf, 0.5m, 1m or 2m tall poles.

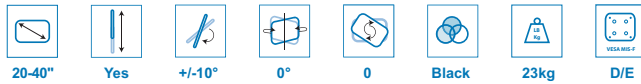

### VisionPro C1200 Plasma Ceiling Mount



The **ErgoMounts** EMVPC1200 is a high capacity plasma /LCD ceiling mount (with up to +/-10° of tilt) for screen sizes 20" - 40". Supports VESA 100mm x 100mm, 200mm x 100mm with an optional 200mm x 200mm interface plate available. Back to back configurations are available on request. Pole drops from 0.5m through to 3.0m available. Black finish.

LCD size: 20"-40"  
 Movement: +/-10° tilt  
 VESA: 100mm x 100mm and 200mm x 100mm  
 Pole drops: 0.5m - 3.0m  
 Max weight capacity: 23kg  
 Finish colour: Black plate, chrome pole.  
 Optional extras: 200mm x 200mm interface plates. Back to Back interface.

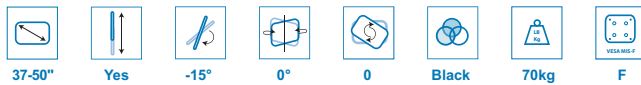

### VisionPro C1250 Plasma Ceiling Mount



The **ErgoMounts** EMVPC1250 is a high quality plasma / LCD ceiling mount (with up to 20° of tilt) for screen sizes 37" - 50". Adjustable mounting supports VESA 600mm x 400mm standard (optional 200mm x 200mm, 800mm x 400mm and back to back interface plates) with pole drops from 0.5m to 3.0m available. Black finish.

LCD size: 37" - 50"  
 Movement: Up to 15° tilt  
 VESA: 600mm x 400mm  
 Pole drops: 0.5m - 3.0m  
 Max weight capacity: 70kg  
 Finish colour: Black plate, chrome pole.  
 Optional extras: 200mm x 200mm, 800mm x 400mm interface plates. Back to back interface.



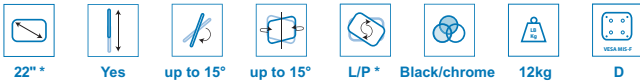

## VisionPro F1500X Series

\* Dependent upon configuration

The **ErgoMounts** VisionPro F1500X Series is the ultimate future proof range of multiple LCD mounting solutions. Solid designs combined with flexible configurations supporting your needs today as well as tomorrow. Multiple horizontal configurations allow monitors to tilt, angle left to right and move through landscape to portrait. The 720mm x 495mm heavy duty base can be bolted to the floor when extra stability is required.

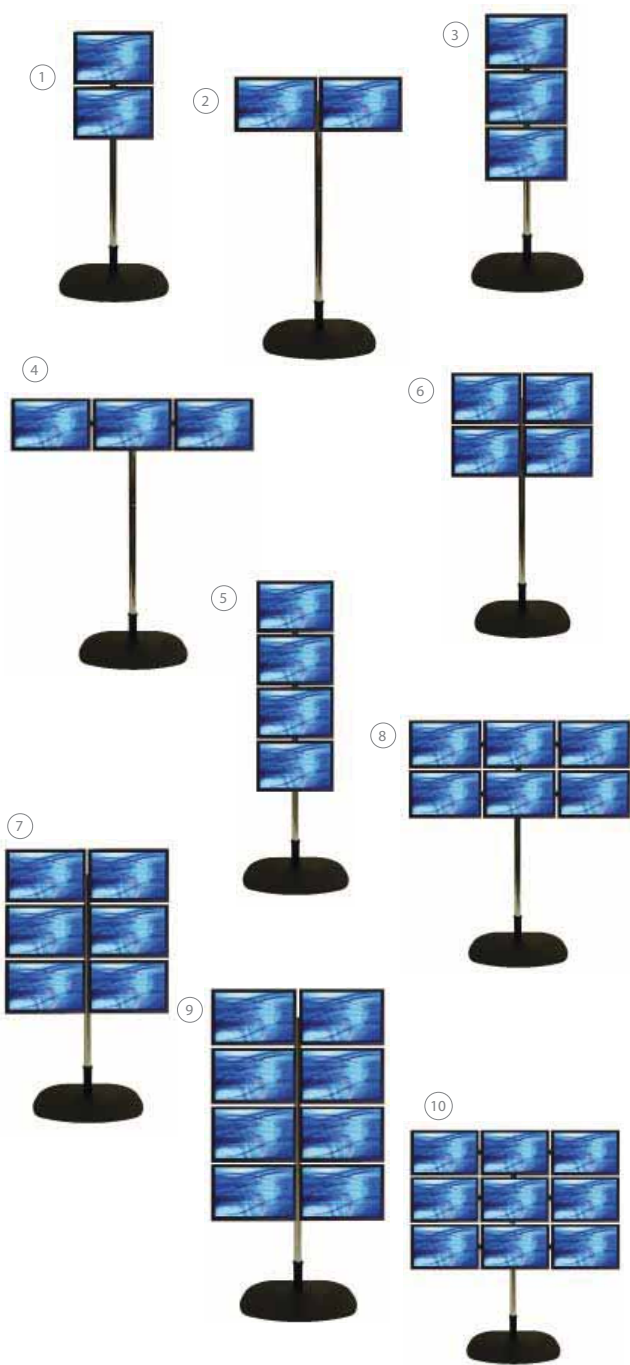

**1 Dual Mount Vertical** EMVVPF1500X-1x2-18B  
 Monitors supported 2  
 Monitor widths supported 330mm - 550mm  
 Max individual monitor weight 12kg

**2 Dual Mount Horizontal** EMVVPF1500X-2X1-18B  
 Monitors supported 2  
 Monitor widths supported 330mm - 550mm  
 Max individual monitor weight 12kg

**3 Triple Mount Vertical** EMVVPF1500X-1X3-18B  
 Monitors supported 3  
 Monitor widths supported 420mm - 550mm  
 Max individual monitor weight 10kg

**4 Triple Mount Horizontal** EMVVPF1500X-3X1-18B  
 Monitors supported 3  
 Monitor widths supported 330mm - 550mm  
 Max individual monitor weight 10kg

**5 Quad Vertical** EMVVPF1500X-1X4-18B  
 Monitors supported 4  
 Monitor widths supported 330mm - 550mm  
 Max individual monitor weight 10kg

**6 Quad (2 above 2)** EMVVPF1500X-2X2-18B  
 Monitors supported 4  
 Monitor widths supported 330mm - 550mm  
 Max individual monitor weight 10kg

**7 6 Way (2 wide x 3 high)** EMVVPF1500X-2X3-18B  
 Monitors supported 6  
 Monitor widths supported 330mm - 550mm  
 Max individual monitor weight 7.5kg

**8 6 Way (3 wide x 2 high)** EMVVPF1500X-3X2-18B  
 Monitors supported 6  
 Monitor widths supported 420mm - 550mm  
 Max individual monitor weight 7.5kg

**9 8 Way (2 wide x 4 high)** EMVVPF1500X-2X4-18B  
 Monitors supported 8  
 Monitor widths supported 330mm - 550mm  
 Max individual monitor weight 6.5kg

**10 9 Way (3 wide x 3 high)** EMVVPF1500X-3X3-18B  
 Monitors supported 9  
 Monitor widths supported 420mm - 550mm  
 Max individual monitor weight 5.5kg

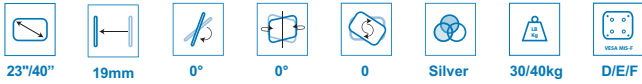

### FX Series (EMFX100/200)



Flat to wall two piece fixed position mounting bracket for VESA 75mm x 75mm and 100mm x 100mm LCD monitors and TVs. Silver finish.

LCD size: 23"/40"  
 VESA: 75mm x 75mm, 100mm x 100mm, 200mm x 100mm, 200mm x 200mm  
 Distance from wall: 19mm  
 Max weight capacity: 30kg/40kg  
 Finish colour: Silver

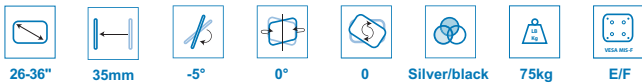

### MZ Series (EMZ300)



Universal LCD wall mount for LCD monitors and TVs 26" - 36". Can be mounted flat or with -5° tilt. Slim line design with universal mounting adjustment and sliding security bar. Silver or black finish.

LCD size: 26" - 36"  
 VESA: 200mm x 100mm, 200mm x 200mm, 400mm x 200mm  
 Distance from wall: 35mm  
 Max weight capacity: 75kg  
 Finish colour: Silver or black

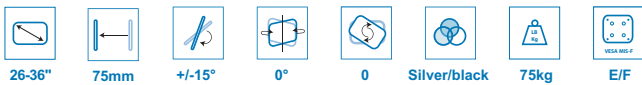

### MZ Series (EMZ400)

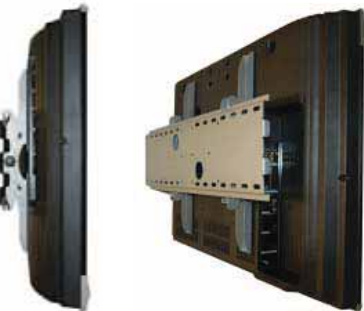

Universal LCD wall mount with vertical tilt (+/- 15° variable) for LCD monitors and TVs 26" - 36". Easily installed slim line design with universal mounting adjustment. Silver or black finish.

LCD size: 26" - 36"  
 Movement: Tilt +/- 15°  
 VESA: 200mm x 100mm, 200mm x 200mm, 400mm x 200mm  
 Distance from wall: 0-75mm  
 Max weight capacity: 75kg  
 Finish colour: Silver or black

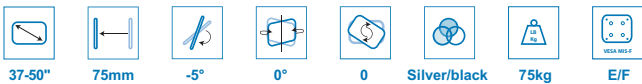

### MZ Series (EMZ100)



Universal LCD wall mount for LCD monitors and TVs 37" - 50". Can be mounted flat or with -5° tilt. Slim line design with universal mounting adjustment and sliding security bar. Silver or black finish.

LCD size: 37" - 50"  
 VESA: 200mm x 100mm, 200mm x 200mm, 600mm x 400mm  
 Distance from wall: 0 - 75mm  
 Max weight capacity: 75kg  
 Finish colour: Silver or black

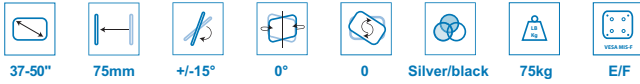

## MZ Series (EMZ200)



EMZ200



EMZ200B

Universal LCD wall mount with +/- 15° tilt for LCD monitors and TVs 37" - 50". Easily installed, slim line design with universal mounting adjustment. Silver or black finish.

LCD size: 37" - 50"  
 Movement: Tilt +/- 15°  
 VESA: 200mm x 100mm, 200mm x 200mm, 600mm x 400mm  
 Adjustable Mounting: 60mm - 770mm (w) 80mm - 480mm (h)  
 Distance from wall: 0 - 75mm  
 Max weight capacity: 75kg  
 Finish colour: Silver or black

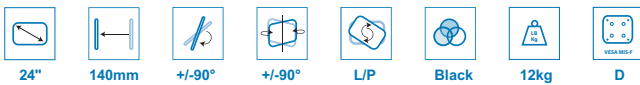

## Delta Series Triple Pivot EM170B



EM170B

Triple pivot direct LCD monitor / TV wall mount for VESA 75mm and 100mm. Touch screen stable. Incorporates +/- 90° tilt and +/-90° swivel. Black finish.

LCD size: 24"  
 Movement: Tilt, swivel and reach  
 VESA: 75mm x 75mm and 100mm x 100mm  
 Distance from wall: 140mm  
 Max weight capacity: 12kg  
 Finish colour: Black

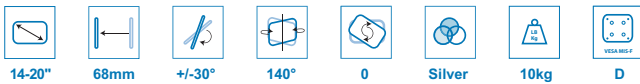

## MX Series EMX100



EMX100

Compact adjustable LCD monitor / TV wall mount for VESA 75mm and 100mm LCD monitors and TVs. Incorporates +/- 30° tilt and 140° swivel. Silver finish.

LCD size: 14" - 20"  
 Movement: Tilt, swivel and reach  
 VESA: 75mm x 75mm and 100mm x 100mm  
 Distance from wall: 48mm folded, 68mm extended  
 Max weight capacity: 10kg  
 Finish colour: Silver

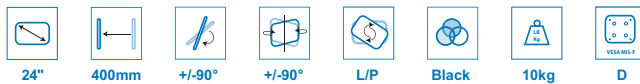

## Delta Series Swing Arm EM178A



EM178A

A highly functional cost-effective arm suitable for LCD/TFT monitors or LCD TVs. Touch screen stable. Supports monitors up to 24" and provides up to 400mm of reach. Black finish.

LCD size: 24"  
 Movement: Tilt, swivel and reach  
 VESA: 75mm x 75mm, 100mm x 100mm  
 Distance from wall: 400mm extended  
 Max weight capacity: 10kg  
 Finish colour: Black





### MX Series (EMX300)



EMX300

Adjustable LCD monitor / TV wall mount for VESA 75mm and 100mm LCD monitors and TVs. Incorporates +/- 30° tilt and 140° swivel. Silver finish.

LCD size: 14" - 20"  
 Movement: Tilt +/- 30°  
 VESA: 75mm x 75mm and 100mm x 100mm  
 Distance from wall: 38mm folded, 380mm extended  
 Max weight capacity: 10kg  
 Finish colour: Silver

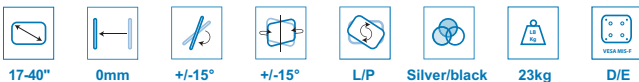

### Pro Series EM230



EM230B



EMVESA200B

High capacity mounting solution for monitors up to 23kg. With +/- 15° of tilt and 360° of rotation possible, with a mounting of only 65mm from the wall. Black finish.

LCD size: 17" - 40"  
 Movement: +/- 15° tilt, +/- 15° swivel  
 VESA: 75mm x 75mm, 100mm x 100mm and 200mm x 100mm  
 Adjustable mounting: None  
 Max weight capacity: 23kg  
 Finish colour: Black  
 Optional extras: Adaptor plate to convert 100mm x 100mm to 200mm x 200mm.

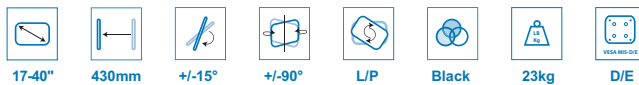

### Pro Series EM250B



EM250B



EMVESA200B

High capacity LCD/TV monitor arm for screens 17" - 40". An ideal corner mount with hidden wall fixings that can extend to 430mm. Black finish.

LCD size: 17" - 40"  
 Movement: Tilt, swivel and reach  
 VESA: 75mm x 75mm, 100mm x 100mm, 200mm x 100mm, 200mm x 200mm.  
 Distance from wall: 100mm folded, 430mm extended  
 Max weight capacity: 23kg  
 Finish colour: Black

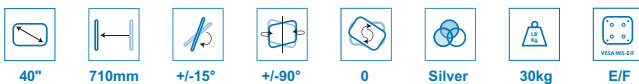

### MZ Series EMZ415 Plus EMZ400



EMZ415



EMZ400

High capacity LCD/TV monitor arm supporting LCD/TVs up to 40" and plasmas up to 36". An ideal corner mount that can extend up to 710mm. Silver finish.

LCD size: 26" - 36" (40" LCDs)  
 Movement: Tilt, swivel and reach  
 VESA: 200mm x 100mm, 200mm x 200mm, 400mm x 200mm and 600mm x 400mm  
 Distance from wall: 130mm folded, 710mm extended  
 Max weight capacity: 30kg  
 Finish colour: Silver

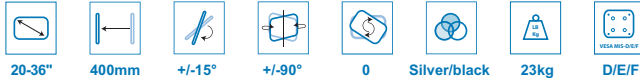

## MZ Series EMZ450

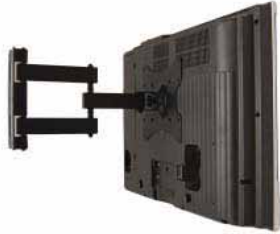

EMZ450S



EMZ450B

*High capacity articulating wall mount arm for screens up to approx 36" in size, 23kg in weight. An ideal corner mount extended up to 400mm. Silver or black finish.*

|                      |  |
|----------------------|--|
| LCD size:            | 20" - 36"                                      |
| Movement:            | Tilt, swivel and reach                         |
| VESA:                | 100mm x 100mm, 200mm x 100mm and 200mm x 200mm |
| Distance from wall:  | 85mm folded, 400mm extended                    |
| Max weight capacity: | 23kg   |
| Finish colour:       | Silver or black                                |



## MZ Series EMZ500S

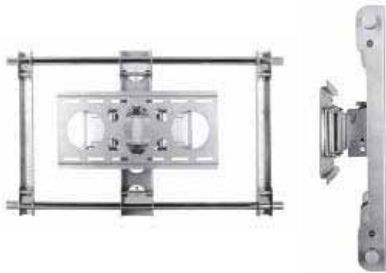

EMZ500S

*A compact, rugged mounting solution for large LCD displays and plasma TVs up to 50" in size. The mount provides up to 300mm of extension. Silver or black finish.*

|                      |  |
|----------------------|--|
| LCD size:            | 37" - 50"                                      |
| Movement:            | Tilt, swivel and reach                         |
| VESA:                | 100mm x 100mm, 200mm x 100mm and 200mm x 200mm |
| Distance from wall:  | 120 mm folded, 300mm extended                  |
| Max weight capacity: | 50kg   |
| Finish colour:       | Silver   |



## Pro Series EM380B Swing Arm



EM380B

*A full articulation swingout mount for LCD, LED TVs up to 136kg. The mount provides up to 660mm of extension and supports monitors up to 90" or 136kg in weight. Black finish.*

|                      |  |
|----------------------|--|
| LCD size:            | 37" - 90"  |
| Movement:            | Tilt, swivel and reach   |
| VESA:                | 200mm x 200mm, 400mm x 200mm, 400mm x 400mm, 600mm x 400mm, 800mm x 400mm. |
| Distance from wall:  | 100 mm folded, 660mm extended  |
| Max weight capacity: | 136kg  |
| Finish colour:       | Black  |

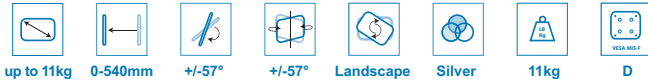

## VisionPro 500 Series Laptop Arm



The VisionPro 500 Series Laptop Support Arm provides the widest range of viewing positions and angles of any laptop arm of its type. Designed to suit any application within the office, production or medical environment. The VisionPro 500 series can be adjusted in height, extension, tilt and swivel to meet all modern ergonomic criterias. Precision manufactured in die-cast aluminium with internal cable management.

The VisionPro 500 series laptop arm supports all known laptops and notebooks. The laptop tray has a specially designed, vented, anti-slip platform which prevents the laptop or notebook from overheating while in use.

Available in a desk or wall mount fitting, compact (360mm max) or extended (540mm max reach), both configurations provide up to 460mm of height adjustment.

Available in a silver finish.

- |  |   |
|--|---|
| <p>1 VisionPro 500 Series compact gas assisted laptop support arm, desk clamp and bolt through desk fitting. Silver finish.</p>  | <p><b>EMVP500S-LTM</b></p>                    |
| <p>Height adjustment<br/>Maximum reach</p>   | <p><b>460mm (18.1")<br/>360mm (14.1")</b></p> |
| <p>2 VisionPro 500 Series extended gas assisted laptop support arm, desk clamp and bolt through desk fitting. Silver finish.</p> | <p><b>EMVP501S-LTM</b></p>                    |
| <p>Height adjustment<br/>Maximum reach</p>   | <p><b>460mm (18.1")<br/>540mm (21.2")</b></p> |
| <p>3 VisionPro 500 Series compact gas assisted laptop support arm, wall mount fitting. Silver finish.</p>                        | <p><b>EMVP500SWM-LTM</b></p>                  |
| <p>Height adjustment<br/>Maximum reach</p>   | <p><b>460mm (18.1")<br/>360mm (14.1")</b></p> |
| <p>4 VisionPro 500 Series extended gas assisted laptop support arm, wall mount fitting. Silver finish.</p>                       | <p><b>EMVP501SWM-LTM</b></p>                  |
| <p>Height adjustment<br/>Maximum reach</p>   | <p><b>460mm (18.1")<br/>540mm (21.2")</b></p> |



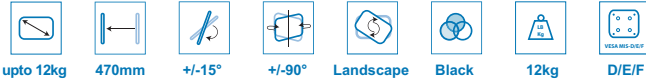

## UltraView 400 Series Laptop Arm



The UltraView 400 Series Laptop Arm is the ideal desk mounting solution where a large range of movement is required. The model is supplied with a bolt through desk fitting or desk clamp. Both mounts can support up to 12kg in weight.

The UltraView 400 series laptop support arm supports all known laptops and notebooks. The laptop tray has a specially designed, vented, anti-slip platform which prevents the laptop from overheating while in use. The 35mm diameter pole allows a huge 400mm of height adjustment, while the dual arm configuration allows a reach of up to 470mm to be achieved. Available in a silver finish.

- 1 UltraView 400 Series Ergonomic laptop arm, desk clamp. Maximum desk thickness 72mm. Maximum mount capacity 12kg. Silver finish. **EMUV400-LTM-DC**
- 2 UltraView 400 Series Ergonomic laptop arm, bolt through desk fitting. Maximum desk thickness 72mm. Maximum mount capacity 12kg. Silver finish. **EMUV400-LTM-TD**

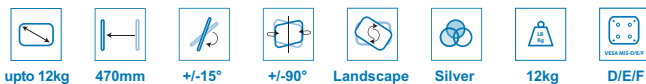

## UltraView 428 Series Dual Laptop Arm



The UltraView 428 Series Dual Support Arm can support a laptop and LCD/TV, each up to 12kg in weight on a single 35mm pole in a horizontal mounting configuration. Supplied with a bolt through fitting or desk clamp.

The robust and durable ergonomic design offers between 70mm and 470mm of reach along with 400mm of height adjustment. Up to +/-90° of monitor swivel is achievable in this highly aesthetic touch screen stable product. Available in a silver finish.

- 1 UltraView 428 Series dual monitor and laptop support arm, desk clamp fitting. Silver finish. **EMUV428-LTM-DC**
- 2 UltraView 428 Series dual monitor and laptop support arm, bolt through desk fitting. Silver finish. **EMUV428-LTM-TD**



## X-5 Delta Series EMDS-X5



Suitable with over 99% of LCD projectors. The X-5 has a keyhole 'hook-on' feature to ensure easy installation and is supplied with a safety bolt for additional security. The projector can also be mounted directly to the carousel.

Fully adjustable, +/-180° rotation and +/-15° of tilt and roll. Ceiling drops available as standard are 190mm (7.5"), 895mm (37.5"), 1145mm (45.1") and 1645mm (64.8"). The X-5 Delta series mount is capable of supporting projectors up to 10kg. Available with a black ceiling plate.

|                      |              |
|----------------------|--------------|
| Ceiling drop:        | up to 1645mm |
| Tilt Adjustment:     | +/-15°       |
| Roll:                | +/-15°       |
| Swivel:              | +/-180°      |
| Finish colour:       | Black        |
| Max weight capacity: | 10kg         |

- |   |  |                    |
|---|--|--------------------|
| 1 | X-5 Delta Series short drop universal projector ceiling mount. 190mm (7.4") Ceiling drop. 22kg max weight.   | <b>EMDS-X5-010</b> |
| 2 | X-5 Delta Series medium drop universal projector ceiling mount. 895mm (35.2") Ceiling drop. 22kg max weight. | <b>EMDS-X5-075</b> |
| 3 | X-5 Delta series 1m drop universal projector ceiling mount. 1145mm (45.1") Ceiling drop. 22kg max weight.    | <b>EMDS-X5-100</b> |
| 4 | X-5 Delta series long drop universal projector ceiling mount. 1645mm (64.8") Ceiling drop. 22kg max weight.  | <b>EMDS-X5-150</b> |

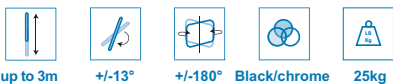

## X-3 Series EMPRO-X3 Extended



Suitable with over 99% of LCD projectors. Unique levelling barrel insures a perfectly level installation and a full 360° rotation. Standard configurations are available in 0.25m, 0.5m, 1m, 2m and 3m drops, though longer poles are available on request. Supports projectors up to 28kg.

|                      |                   |
|----------------------|-------------------|
| Ceiling drop:        | up to 3m          |
| Tilt Adjustment:     | +/-13°            |
| Swivel:              | +/-180°           |
| Finish colour:       | Black/chrome pole |
| Max weight capacity: | 25kg              |



## UniFlex Series CPU Holders

The **ErgoMounts UniFlex Series CPU holders** sleek design compliments the modern office. Possibly the UK's best selling CPU holder. British manufactured and supplied virtually fully assembled for reduced installation times. Available in three sizes. Supports CPUs weighing up to 45kg. Complete with screw fitting to attach to the under side of the worksurface.

Silver or black finish.



- |  |                     |
|--|---------------------|
| 1 UniFlex Narrow adjustable CPU holder, supports CPUs; 90mm - 125mm (W), 310mm - 500mm (H). Silver finish.   | <b>EMUNICPU661S</b> |
| 2 UniFlex Narrow adjustable CPU holder, supports CPUs; 90mm - 125mm (W), 310mm - 500mm (H). Black finish.    | <b>EMUNICPU661B</b> |
| 3 UniFlex Standard adjustable CPU holder, supports CPUs; 120mm -170mm (W), 325mm - 515mm (H). Silver finish. | <b>EMUNICPU662S</b> |
| 4 UniFlex Standard adjustable CPU holder, supports CPUs; 120mm -170mm (W), 325mm - 515mm (H). Black finish.  | <b>EMUNICPU662B</b> |
| 5 UniFlex Wide adjustable CPU holder, supports CPUs; 165mm -215mm (W), 325mm - 515mm (H). Silver finish.     | <b>EMUNICPU663S</b> |
| 6 UniFlex Wide adjustable CPU holder, supports CPUs; 165mm -215mm (W), 325mm - 515mm (H). Black finish.      | <b>EMUNICPU663B</b> |



## Cobra CPU Holders

The **Cobra Under Desk CPU Holder** provides a sleek, elegant support for all size CPUs up to 330-570mm high x 0-75mm and 115-200mm wide.

The high quality, all metal design adjusts to the size of your CPU with toolless adjustment.

The Cobra is supplied fully assembled in a silver finish and can accommodate CPUs up to 30kg in weight.

Available in a silver finish.



- |  |                    |
|--|--------------------|
| 1 Cobra CPU holder, supports CPUs up to 330-570mm high x 0-75mm and 115-200mm wide. Silver finish. | <b>EMCPUCOB-1S</b> |
| 2 Cobra 2 Thin Client holder, supports 110-300mm (h) x 0-90mm (w), Silver finish.                  | <b>EMCPUCOB-2S</b> |





## SF Series Wall Mount CPU Holders

The EMSFCPU-WM Wall Mount CPU Holder provides a sleek, elegant support for Small form factor CPUs up to 15kg in weight. Two size options are available, narrow for CPUs between 61mm and 102mm wide and standard for CPUs between 81mm and 120mm wide. The EMSFCPU-WM has the benefit of a zero footprint both on the floor and on the desk and can be positioned at any height to suit the required location. The high quality, all metal design is quick and easy to install and fits to the size of your CPU with adjustable clamp technology.

The CPU holder can also be mounted to a 50mm pole using an optional 50mm accessory collar. The EMSFCPU-WM can accommodate CPUs up to 15kg in weight.

Available in a medical white or black finish.

- |   |   |                         |
|---|---|-------------------------|
| 1 | SF series wall mount CPU holder. Supports CPUs from 61mm - 102mm. Medical White finish. | <b>EMSFCPU-WM-MW</b>    |
| 2 | SF series wall mount CPU holder. Supports CPUs from 61mm - 102mm. Black finish.         | <b>EMSFCPU-WM-TB</b>    |
| 3 | SF series wall mount CPU holder. Supports CPUs from 81mm - 120mm. Black finish.         | <b>EMSFCPU120-WM-TB</b> |



## UniMount CPU Holders

The ErgoMounts UniMount CPU Holder is a UK manufactured, cost effective, high quality all metal construction CPU mount designed to mount a CPU to the underside of a work surface to free up desk space.

The UniMount CPU holder supports CPUs with maximum dimensions 200mm (EMUNICPU61) or 135mm (EMUNICPU62) wide and 465mm high and requires minimal on site assembly. The CPU is supported by two sliders which adjust to the dimensions of the individual CPUs.

Available in silver finish.

- |   |   |                    |
|---|---|--------------------|
| 1 | UniMount CPU holder, supports CPUs; 100mm - 200mm (W). Silver finish. | <b>EMUNICPU61S</b> |
| 2 | UniMount CPU holder, supports CPUs; 95mm - 130mm. Silver finish.      | <b>EMUNICPU62S</b> |

## Floor Plates and Bases



### 1 Pro Series EMPRO-PS Base

Heavy weight base, single 50mm central column entry. 600mm x 600mm external dimensions. Supports up to 45kg dependent upon configuration. Combine with 50mm diameter poles up to 2.0m. Black finish.



### 2 Pro Series EMPRO-T Base

Heavy weight base, dual 50mm rear column entry. 900mm x 750mm external dimensions. Supports up to 73kg dependent upon configuration. Combine with 50mm diameter poles up to 2.0m. Black finish.



### 3 Delta Series EMDSFS-LB

Heavy weight base, large 935mm x 642mm dual 60mm column entries. Supports up to 70kg dependent upon configuration. Combine with FS series 60mm diameter poles up to 2.0m. Black or silver finish.



### 4 VisionPro F1500-MB

Heavy weight base, medium 720mm x 494mm, single 50mm column entry. Supports up to 24kg dependent upon configuration. Combine with FS series 50mm diameter poles up to 2.0m. Black or silver finish.



### 5 Delta Series EMDSFS-SB

Heavy weight base, small, 576mm x 395mm single 60mm column entry. Supports up to 15kg dependent upon configuration. Combine with FS series 60mm diameter poles up to 2.0m. Black or silver finish.



### 6 Delta Series EMDSCMP-LB

Bolt down floor plate. Single 50mm central column entry. 290mm x 235mm external dimensions. Supports up to 40kg in floor mount orientation (dependent upon configuration). Combine with 50mm diameter poles. Black finish.



### 7 Delta Series EMDSCMP-SB

Small floor / ceiling mount plate. Single 50mm central column entry. 150mm diameter external dimensions. Supports up to 23kg in floor mount orientation (dependent upon configuration). Combine with 50mm diameter poles. Black or silver finish.



## Ceiling Plates and Attachments

- 1 **Pro Series EMDSCMP-LB-TILT**  
Large floor / ceiling mount plate. Single 50mm central column entry. 300 diameter dimensions. Supports up to 140kg dependent upon orientation / configuration. Combine with 50mm diameter poles. Black finish.
  
- 2 **Delta Series EMDSCMP-SB**  
Small floor / ceiling mount plate. Single 50mm central column entry. 150mm diameter external dimensions. Supports up to 90kg in ceiling mount orientation (dependent upon configuration). Combine with 50mm diameter poles. Black or silver finish.
  
- 3 **Delta Series EMDSCMP-SB-TILT**  
Delta series small, heavy duty tilting ceiling plate. 240mm diameter external plate dimensions. 50mm column entry. Supports up to 145kg. Combine with 50mm diameter poles. Black finish.
  
- 4 **Delta Series EMDSTM50B**  
Designed to suspend 50mm diameter poles from 42mm - 50mm horizontal poles. Supports up to 140kg dependent upon configuration. Combine with 50mm diameter poles. Black or silver finish.
  
- 5 **Pro Series EMPRO-ITC1016C**  
Heavy duty girder mount for 50mm diameter poles. EMPRO-ITC1016 adjusts from 80mm (3.1") - 250mm (9.8"). Supports up to 88kg. Combine with 50mm diameter poles. Black finish.
  
- 6 **Delta Series EMDS725B**  
Column adaptor for horizontal to vertical poles. Use with EMDS50COL 50mm collars. Allows connections to be made between poles of differing orientations. Black or silver finish.
  
- 7 **VisionPro EMVPFR-C**  
Finishing ring, 50mm internal. For use with 50mm diameter poles to tidy pole entries through suspended ceilings. Chrome, black or white finishes available.





## Poles and Joiners

- 1 **Delta Series EMDSCOL50-1C**  
50mm diameter column. Available in 0.5m, 1.0m, 1.5m and 2.0m lengths as standard. Up to 3.0m lengths available to order. Chrome finish as standard. Black finish available to order. Use with 50mm ceiling, floor or wall plates.  
**EMDSCOL50-1C (1.0m chrome).**
  
- 2 **Pro Series EMPROCOL-1B**  
50mm diameter column. Available in 0,5m, 1.0m, 1.5m, 2.0m and 3.0m lengths as standard. Poles can also be joined using couplers. Black finish as standard. Use with 50mm ceiling, floor or wall plates.  
**EMPROCOL-1B (1.0m black).**
  
- 3 **Pro Series EMPROFSCOL72C**  
50mm diameter cable managed column for use with Pro series floor stands/trolleys. Available in 1.83m and 2.13m lengths. Poles can also be joined using couplers. Chrome finish as standard.  
**EMPROFSCOL72C (1.83m chrome).**
  
- 4 **Delta Series EMDSFSCOL15C**  
60mm diameter cable managed column for use with Delta series floor stands. Available in 1.0m, 1.5m and 2.0m lengths. Chrome finish as standard.  
**EMDSFSCOL15C (1.5m chrome).**
  
- 5 **Delta Series EMDS723C-50**  
Internal pole couple for use with Delta series and Pro series 50mm diameter poles. Joins poles without reducing width capacity in vertical orientations. Zinc finish.  
**EMDS723C-50 (zinc).**
  
- 6 **Delta Series EMDS724C-50**  
External pole couple for use with Delta series and Pro series 50mm diameter poles. Joins poles without reducing width capacity in vertical orientations. Black or chrome finish.  
**EMDS724C-50 (chrome)**
  
- 7 **Delta Series EMDS707B**  
Open end ring for 50mm diameter poles. Allows cables to pass through whilst being protected against any rough pole edges. Provides a professional neat finish. Black or silver finish.  
**EMDS707-B (black).**
  
- 8 **Delta Series EMDS705B**  
Closed end cap for 50mm diameter poles. Provides a professional neat finish. Black or silver finish.  
**EMDS705-B (black).**

## Collars and Interfaces

①



**1 Delta Series EMDS50COLB**

Collar for use with 50mm diameter poles. Compatible with most Delta series components. Black finish.  
**EMDS50COLB (black).**

②



**2 VisionPro Series EMVP1250TVMB**

Tiltable 50mm pole interface for use on 50mm diameter vertical poles. Accepts EM850/860 and EM507 interfaces. Supports up to 70kg dependent upon configuration. Combine with 50mm diameter poles up to 2 metres. Black finish.  
**EMVP1250TVMB (black).**

③



**3 Delta Series EMDSTVM**

Tiltable VESA interface for use with EMDS50COL. Includes 75mm and 100mm VESA interface. Supports up to 20kg. Tilts up to 15° downwards. Black or silver finish.  
**EMDSTVMS (silver). EMDSTVMB (black).**

④



**4 Pro Series EMPRO-PRC2**

Heavy duty tilt and rotate 50mm diameter end column VESA interface. Tilts up to +/-15° and rotates a full 360°. Supports up to 23kg. Supports VESA 75mm x 75mm, 100mm x 100mm, and 200mm x 100mm. Optional 200mm x 200mm interface plate. Black finish.  
**EMPRO-PRC2.**

⑤



**5 Delta Series EMDS507B**

Heavy duty VESA 200mm x 200mm, 200mm x 100mm, 100mm x 100mm and 75mm x 75mm interface for use with EMVP1250TVMB. Supports up to 70kg. Silver or black finish.  
**EMDS507B (black).**

⑥



**6 Delta Series EMDS850B**

Heavy duty adjustable LCD/Plasma interface. Supports VESA 600mm x 400mm, 400mm x 200mm, along with hole spacings 100mm - 410mm (h) and 280mm - 755mm (w). For use with EMVP1250TVMB. 800mm x 400mm version available. Supports up to 70kg. Silver or black finish.  
**EMDS850B (black).**

⑦



**7 Pro Series EMCTM-MS2**

Pro Series tiltable interface for use with 50mm Pro series collars and interfaces. Tilts up to 12° downwards. EMCTM-MS2 supports most screens 37" - 55". Black finish.  
**EMCTM-MS2.**

⑧



**Pro Series EM230B**

8 Heavy duty tilt and rotate VESA interface. Tilts/rotates up to 15°. Supports up to 23kg. Supports VESA 75mm x 75mm, 100mm x 100mm and 200mm x 100mm. Optional 200mm x 200mm interface plate. Black finish.  
**EM230B (black).**

①



②



③



④



⑤



⑥



⑦



⑧



⑨



## Interfaces and Shelves

- 1 **Delta Series EMVESA210B**  
200mm x 100mm VESA conversion plate. Picks up on VESA 100mm holes. Supports 23kg. 200mm x 200mm VESA interface also available, part number EMVESA200B. **EMVESA210B (black).**
- 2 **VisionPro Series EM715162**  
Glass multimedia shelf for use with 50mm diameter single columns. 470mm x 370mm. Supports up to 7.5kg. Complete with 50mm collar. **EM715162.**
- 3 **EMPRO-MTL-SHGB**  
Metal multimedia shelf for use with Phoenix, ProView and Trident dual 50mm columns. Supports up to 12kg. 500mm x 390mm (19.68" - 15.35").
- 4 **Delta Series EMVESA200B**  
200mm x 200mm VESA conversion plate. Picks up on VESA 100mm x 100mm holes. Supports 23kg. Silver or black finish.
- 5 **EMPRO-VC-SHGB**  
Video conferencing equipment shelf, black and chrome, for use with Phoenix, ProView and Trident support stands/trolleys.
- 6 **EM704706B**  
Multimedia shelf and collar, for use with dual 60mm diameter columns.
- 7 **EMSFCPU-WM**  
The EMSFCPU-WM wall mount CPU holder provides a sleek, elegant support for Small Form Factor CPUs between 61mm and 102mm wide. The EMSFCPU-WM wall mount CPU holder has the benefit of a zero footprint both on the floor and on the desk and can be positioned at any height to suit the required location. Available in Medical white or black finish.
- 8 **EMCPUFF/EMCPUSF**  
Wall mount CPU holders, constructed from heavy duty aluminium and designed to wall mount CPUs. Available in two widths; standard 100mm (4") x 205mm (8.4") or narrow 50mm (2") x 116mm (4.6") and light grey, black or medical white finish.
- 9 **EMCPUFF-PM1/EMCPUSF-PM1**  
Pole mount CPU holders, constructed from heavy duty aluminium to provide a strong and reliable pole clamp support. Available in two widths; standard 100mm (4") x 213mm (8.4") or narrow 50mm (2") x 116mm (4.6"). Light grey, black or medical white finish.





**Custom Design Services** Our customer focused custom design department has a vast experience of designing and manufacturing solutions tailored to meet your exact requirement. Key areas such as point of sale, digital signage and multiple mount configurations are our speciality.

**Digital Signage** Multimedia displays can be positioned virtually anywhere required to display information 24/7. Through working closely with the client we can develop the most appropriate mounting solution.

**Multiple Screen Configurations** Displaying information across multiple screens is now common practice and not limited by technology. **ErgoMounts** can create the most efficient and stylish multiple screen solutions tailored to your requirements.

**Bespoke Computer Workstations** Not sure exactly what you need? Contact us with your ideas and we can assist in progressing it to reality. Computer work stations can be configured to support all of your equipment and can incorporate anti-tamper fittings.



## Multiple LCD/Plasma Ceiling Mounts

An almost infinite number of configurations are available to mount multiple LCD or Plasma screens from ceilings. Configurations can be created to match your ideal display patterns, often from off the shelf components.



### Multiple LCD/Plasma Ceiling Mounts

Floor to ceiling mount configurations can be eye catching as well as allowing displays to be positioned in areas otherwise deemed to be out of bounds. By anchoring at both the top and bottom of the poles, each configuration has added stability. Due to the modularity of the components, each system is future proofed enabling additional or larger screens to be added at a later date.

**ErgoMounts** can also provide full installation service for all mounting solutions subject to an initial site survey.

### Mixed Media Size Mounts

In addition to multiple ceiling and floor to ceiling mounts we are able to provide mixed media mounting solutions. These can comprise of mixed screen sizes or mixed media. Plasma, LCD and Projector technology can be incorporated on to a single mounting solution.

Simply state the models along with the intended configuration and we will create the solution to best meet your requirements.

We specialise in solutions for office/financial environments, hospitality, medical and retail.

***“ErgoMounts can also provide full installation service for all mounting solutions subject to an initial site survey.”***



## iPad Mounting Solutions

The launch of the iPad opened up a new range of Solutions for ErgoMounts. The versatility of the iPad has meant that the demand and scope for mounting solutions has been immense.

ErgoMounts offer a wide range of ergonomic, space efficient security and quick release mounts for the iPad. Ideal for use at RoadShows, Exhibitions and Retail Outlets these are available in wall mount, desk mount and workstation configurations.



- 5 **EM2260W-IPS50**  
The Delta Series Articulating Arm is a highly adjustable, durable pole mount for the iPad, including the new iPad Air. Extends up to 400mm from pole and rotates 180°.
- 6 **EMUV420TD-IPS50**  
The UltraView 420 Series iPad Quick Release Dual Horizontal desk mount is a unique revolutionary ergonomic mounting solution for supporting the range of Apple iPads (including the iPad Air) alongside your desktop monitor.
- 7 **EMIPS50**  
The EMIPS50 iPad freestanding mount is designed to compliment the sleek design of the Apple iPad (including the iPad Air), whilst providing a flexible, stable platform to enhance functionality.
- 8 **EM820-50-IPS50**  
The SS series is a neat, touch screen stable solution with a range of movement, including +/-37.5° of tilt and swivel, plus landscape to portrait rotation. Compatible with the full range of iPad solutions including the newly released iPad Air.



- EMIPS80FSS**  
1 The ErgoMounts secure desktop stand / enclosure is designed to compliment the sleek design of the revolutionary iPad / iPad 2 / the new iPad (iPad 3) and iPad 4, whilst providing a flexible, stable platform to enhance functionality.
- 2 **EM171B-IPS65**  
The ErgoMounts i-Secure Point of Sale (P.O.S) mount/ enclosure is designed to work with all variants of the iPad including the new iPad 4.
- 3 **EMVPF1280-1B-IPS80**  
The ErgoMounts VisionPro F1280 Secure iPad, iPad 2, iPad 3 and iPad 4 Adjustable Floor Mount is an ideal solution for use in P.O.S, exhibition and conference environments or for airport check-in facilities
- 4 **EMVP500S-IPS80**  
The ErgoMounts VisionPro 500 series is a unique revolutionary ergonomic mounting solution for the Apple iPad, iPad 2, iPad 3 and iPad 4. A gas assisted strut and ball joint allow effortless adjustment to the height, tilt, swivel and orientation of the iPad.







See it your way...

© ErgoMounts v6 012015