

CP-118U/138U

8-port RS-232/422/485 Universal PCI serial boards

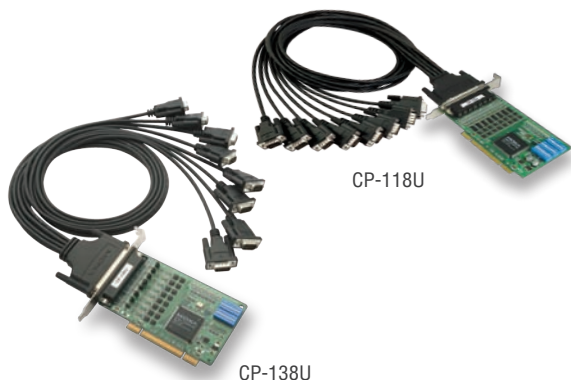

- > Over 700 Kbps data throughput for top performance
- > 921.6 Kbps maximum baudrate for super fast data transmission
- > 128-byte FIFO and on-chip H/W, S/W flow control
- > Compatible with 3.3/5V PCI and PCI-X
- > Drivers provided for Windows (7 x86/x64, XP/2003/Vista/2008 x86/x64, 2000/9X/ME/NT), Windows CE 5.0/6.0, Windows XP Embedded, DOS, Linux 2.4, Linux 2.6 (x86/x64), FreeBSD 4/5, QNX 6, SCO Open Server 5/6, UnixWare 7, Solaris 10 x86/x64
- > Easy maintenance with on-board LED display, and management software
- > 15 KV ESD protection on the board
- > Wide temperature model available for -40 to 85°C environments



Overview

The CP-118U and CP-138U are smart, 8-port Universal PCI serial boards designed for POS and ATM applications and for use by industrial automation system manufacturers and system integrators. Both boards are compatible with all major operating systems. In addition, the CP-118U's 8 RS-232/422/485 ports and the CP-138U's

8 RS-422/485 ports support data rates up to 921.6 Kbps, and provide full modem control signals to ensure compatibility with a wide range of serial peripherals. The CP-118U and CP-138U support both 3.3V and 5V PCI buses, making them suitable for installation in most PC servers.

Drivers Provided for Windows and Linux

One of Moxa's highest priorities is to provide drivers for all mainstream operating systems. Reliable, well-tested Windows COM and Linux/Unix TTY drivers are available for use with the CP-118U and CP-138U serial

boards. Other operating systems, such as Windows XP embedded and WEPOS, are also supported to accommodate embedded integration applications.

Specifications

Hardware

Comm. Controller: MU860 (16C550C compatible)

Bus: 32-bit Universal PCI

Connector: DB62 female

Serial Interface

Number of Ports: 8

Serial Standards:

CP-118U: RS-232/422/485

CP-138U: RS-422/485

Max. No. of Boards per PC: 4

Serial Line Protection

ESD Protection: 15 KV on the board

Performance

Baudrate: 50 bps to 921.6 Kbps

Serial Communication Parameters

Data Bits: 5, 6, 7, 8

Stop Bits: 1, 1.5, 2

Parity: None, Even, Odd, Space, Mark

Flow Control: RTS/CTS, XON/XOFF

I/O Address: Assigned by BIOS

IRQ: Assigned by BIOS

Serial Signals

RS-232: TxD, RxD, RTS, CTS, DTR, DSR, DCD, GND

RS-422: TxD+(B), TxD-(A), RxD+(B), RxD-(A), GND

RS-485-4w: TxD+(B), TxD-(A), RxD+(B), RxD-(A), GND

RS-485-2w: Data+(B), Data-(A), GND

Driver Support

Operating Systems: Windows 9X/ME/NT/2000, Windows XP/2003/

Vista/2008/7 x86/x64, Windows CE 5.0/6.0, Windows XP Embedded, DOS, Linux 2.4, Linux 2.6 x86/x64, FreeBSD 4/5, QNX 6, SCO Open Server 5/6, UnixWare 7, Solaris 10 x86/x64

Note: Please refer to Moxa's website for the latest driver support information.

Physical Characteristics

Dimensions: 82 x 135 mm (3.22 x 5.31 in)

Environmental Limits

Operating Temperature:

Standard Models: 0 to 55°C (32 to 131°F)

Wide Temp. Models: -40 to 85°C (-40 to 185°F)

Storage Temperature: -40 to 85°C (-40 to 185°F)

Ambient Relative Humidity: 5 to 95% (non-condensing)

Standards and Certifications

EMC: CE, FCC

EMI: EN 55022, EN 61000-3-2, EN 61000-3-3, FCC Part 15 Subpart B Class B

EMS: EN 55024, IEC 61000-4-2, IEC 61000-4-3, IEC 61000-4-4, IEC 61000-4-5, IEC 61000-4-6, IEC 61000-4-8, IEC 61000-4-11 (DIPS)

Green Product: RoHS, CrRoHS, WEEE

MTBF (mean time between failures)

Time: 1,147,210 hrs

Database: Telcordia (Bellcore), GB

Power Requirements

Power Consumption:

CP-118U: 240 mA @ +5 V (RS-232), 300 mA @ +5 V (RS-422)

CP-138U: 135 mA @ +5V (RS-422)

Warranty

Warranty Period: 5 years

Details: See www.moxa.com/warranty

Dimensions

CP-118U

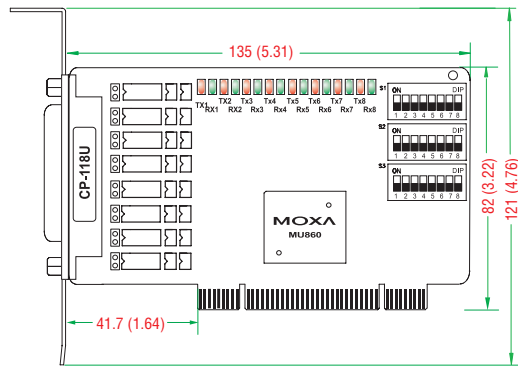

CP-138U

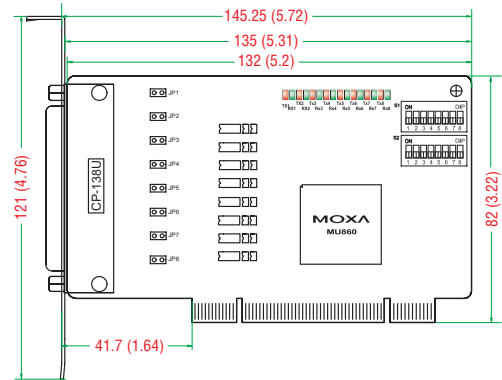

Unit: mm (inch)

Ordering Information

Available Models

CP-118U: 8-port RS-232/422/485 Universal PCI serial board, 0 to 55°C operating temperature

CP-138U: 8-port RS-422/485 Universal PCI serial board, 0 to 55°C operating temperature

CP-118U-T: 8-port RS-232/422/485 Universal PCI serial board, -40 to 85°C operating temperature

CP-138U-T: 8-port RS-422/485 Universal PCI serial board, -40 to 85°C operating temperature

Package Checklist

- 1 CP-118U or CP-138U board
- Documentation and software CD
- Quick installation guide (printed)
- Warranty card

Connection Options (can be purchased separately)

OPT8-M9

DB9 male x 8 (150 cm cable)



CBL-M62M9x8-100 (OPT8D)

DB9 male x 8 (100 cm cable)



PIN	RS-232
1	DCD
2	RxD
3	TxD
4	DTR

PIN	RS-232
5	GND
6	DSR
7	RTS
8	CTS

DB9 male

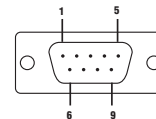

OPT8B

DB25 male x 8 (150 cm cable)



CBL-M62M25x8-100 (OPT8C)

DB25 male x 8 (100 cm cable)



PIN	RS-232
2	TxD
3	RxD
4	RTS
5	CTS

PIN	RS-232
6	DSR
7	GND
8	DCD
20	DTR

DB25 male

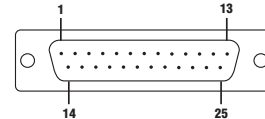

OPT8A

DB25 female x 8 (150 cm cable)



OPT8S

DB25 female x 8 (150 cm cable)
25 KV ESD Surge Protection



PIN	RS-232
2	RxD
3	TxD
4	CTS
5	RTS

PIN	RS-232
6	DTR
7	GND
8	DCD
20	DSR

DB25 female

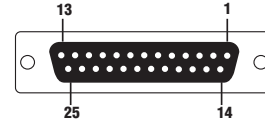

OPT8-RJ45

8-pin RJ45 x 8 (30 cm cable)



PIN	RS-232
1	DSR
2	RTS
3	GND
4	TxD

PIN	RS-232
5	RxD
6	DCD
7	CTS
8	DTR

8-pin RJ45

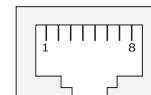

© Moxa Inc. All Rights Reserved. Updated S. 26, 2011. Specifications subject to change without notice. Please visit our website for the most up-to-date product information.